



City of Auburn, Maine

Engineering Department

60 Court Street | Auburn, Maine 04210

www.auburnmaine.gov | 207.333.6601

February 26, 2024

Dear Bidder:

The City of Auburn is accepting written proposals for the Auburn Engineering Department's **2024 Reconstruction Project**. The City reserves the right to accept or reject any or all proposals in whole or in part and to waive any informality the City may determine necessary. The City also reserves itself the exclusive right to accept any proposal when it is deemed by the City to be in its best interest. The City of Auburn is governed by Title 1 M.R.S.A. § 401-410, otherwise known as the Freedom of Information Act, which considers bid specifications as public documents. In awarding any proposal, the City may consider, but not be limited to, any of the following factors: Bidder qualifications, price, experience, financial standing with the City, warranties, references, bonding, delivery date, and service of Bidder. Vendors/Contractors shall be current on all amounts due to the City of Auburn prior to the City entering into any contract agreement. All proposals must include FOB to Auburn, Maine unless otherwise specified.

Proposals will not receive consideration unless submitted in accordance with the following instructions to bidders. Please mark sealed envelopes plainly: **"2024 Reconstruction Project-Bid #2024-022."**

Bid packages will be available beginning on Monday, February 26, 2024. Documents can be obtained from the City of Auburn's website: www.auburnmaine.gov/business/bid-notice. Questions will be fielded until **4:00 p.m. Thursday March 14, 2024**. **There will be a mandatory pre-bid meeting at 2:00pm on Wednesday, March 6th, 2024, in the Community Room (206) at Auburn City Hall.**

Please submit your proposal to the City of Auburn by 2:00 p.m. **Tuesday, March 19th, 2024**. Proposals must be delivered to **Amanda Denning, Purchasing Analyst, 60 Court Street, Auburn, Maine 04210** on or before the date and time appointed. No proposals will be accepted after the time and date listed above. Proposals will be opened at 2:00 p.m. on that date and read aloud.

Sincerely,

Amanda Denning
Purchasing Analyst

Contents

CONDITIONS AND INSTRUCTIONS TO BIDDERS 3
GENERAL CONDITIONS..... 4
BID PROPOSAL FORM 5
BASE BID FORM 6
BID ALTERNATE 7
SCOPE OF WORK..... 8
SPECIAL PROVISIONS..... 9
SECTION 100 - GENERAL PROVISIONS 14
SECTION 202 - REMOVING OF STRUCTURES AND OBSTRUCTIONS..... 15
SECTION 203 – COMMON EXCAVATION 16
SECTION 304 – AGGREGATE BASE COURSE..... 17
SECTION 403 - HOT BITUMINOUS PAVEMENT..... 18
SECTION 409 - BITUMINOUS TACK COAT 19
SECTION 603 - PIPE CULVERTS AND STORM DRAINS.....20
SECTION 604 – CATCH BASINS21
SECTION 605 – UNDERDRAINS.....22
SECTION 608 – PEDESTRIAN RAMP WITH DETECTABLE WARNING SURFACE.....23
SECTION 609 - CURB24
SECTION 615 - LOAM25
**SECTION 626 – FOUNDATIONS, CONDUIT, AND JUNCTION BOXES FOR HIGHWAY
SIGNING, LIGHTING AND SIGNALS.....26**
SECTION 627 – PAVEMENT MARKINGS.....28
SECTION 634 – HIGHWAY LIGHTING29
SECTION 652 – MAINTENANCE OF TRAFFIC32
SECTION 659 – MOBILIZATION.....33
SECTION 830 – SEWER/WATER MAIN SERVICES34
BID BOND36
SAMPLE AGREEMENT37
APPENDIX A43
APPENDIX B.....46
APPENDIX C.....49

CONDITIONS AND INSTRUCTIONS TO BIDDERS

1. Bidders shall use the enclosed bid form for quotations. Whenever, in bid forms, an article is defined by using a trade name or catalog number, the term "or approved equal", if not inserted, shall be implied.
2. Submit a separate unit price for each item unless otherwise specified in the bid request. Award will be made on the basis of each item, or as a group, whichever is in the best interest of the City. Prices stated are to be "delivered to destination".
3. Bid proposals must be completed in full and in ink. Bid proposals **are required to be notarized**. Bids may be withdrawn prior to the time set for the official opening.
4. Bidders or representatives will be able to view the bid tabulation on the City's website.
5. **Awards will be made to the lowest responsible bidder of the Base Bid and Bid Alternate**, considering the quality of the materials, date of delivery, cost which meets specification and is in the best interest to the City of Auburn.
6. All transportation charges, including expense for freight, transfer express, mail, etc. shall be prepaid and be at the expense of the vendor unless otherwise specified in the bid.
7. The terms and cash discounts shall be specified. Time, in connection with discount offered, will be computed from date of delivery at destination after final inspection and acceptance or from date of correct invoice, whichever is later.
8. The City is exempt from payment of Federal Excise Taxes on the articles not for resale, Federal Transportation Tax on all shipments and Maine Sales Tax and Use Taxes. Please quote less these taxes. Upon application, an exemption certificate will be furnished with the Purchase Order when required.
9. No contract may be assigned without the written consent of the Purchasing Director or his designate. The contract shall not be considered valid until a purchase order has been issued to the successful bidder.
10. Please state "2024 Reconstruction Project – Bid # 2024-022", on submitted, sealed envelope.
11. The City of Auburn reserves the right to waive any formality and technicality in bids whichever is deemed best for the interest of the City of Auburn.
12. The completion date for this project is November 8th, 2024. Liquidated damages of \$500/calendar day will be assessed on uncompleted work.

13. Standard AIA Document A312-2010 Payment and Performance Bond forms will be accepted as an alternate Bid Bond form.

GENERAL CONDITIONS

1. Equal Employment Opportunity

The City of Auburn is an Equal Opportunity Employer and shall not discriminate against an applicant for employment, and employee or a citizen because of race, color, sex, marital status, physical and/or mental handicap, religion, age, ancestry, or natural origin, unless based upon a bona-fide occupation qualification. Vendors and Contractor or their agents doing business with the City shall not violate the above clause or the Civil Rights Acts of 1964. Violations by vendors shall be reviewed on a case-by-case basis and may mean an automatic breach of contract or service to the City of Auburn.

2. Save Harmless

The Bidder agrees to protect and save harmless the owner from all costs, expenses or damages that may arise out of alleged infringement of patents of materials used.

3. Subcontracting

The Bidder shall not subcontract any part of the work or materials or assign any monies due to it without first obtaining the written consent of the municipality. Neither party shall assign or transfer its interest in the contract without the written consent of the other party.

4. Warranty

The Bidder warrants that all work will be of good quality and free from faults and defects, and in conformance with the specifications. All work not so conforming to these standards may be considered defective. The Bidder agrees to be responsible for the acts and omissions of all of its employees and all subcontractors, their agents and employees, and all other persons performing any of the work under a contract with the Bidder.

5. Bonds, Retainage and Payments

A bid bond shall be submitted with appropriate bid forms in the amount of 5% of the total contract value. Also, payment and performance bonds will be required from the Contractor who is awarded this contract. Retainage in the amount of 10% will be held from each progress payment and shall be released at the discretion of the Project Manager. Payments shall be made by the City to the Contractor 30 days after receipt of the request for payment.

BID PROPOSAL FORM

Due: Tuesday March 19th, 2024

To: City of Auburn
Amanda Denning, Purchasing Analyst
60 Court Street
Auburn, ME 04210

The undersigned individual/firm/business guarantees this price for thirty days (30) from the proposal due date. The undersigned submits this proposal without collusion with any other person, individual, or firm or agency. The undersigned ensures the authority to act on behalf of the corporation, partnership or individual they represent; and has read and agreed to all of the terms, requests, or conditions written herein by the City of Auburn, Maine.

By signing this form, the firm listed below hereby affirms that its bid meets the minimum specifications and standards as listed above.

Signature _____ Company _____

Name (print) _____ Title _____

Phone Number _____

Address _____

Email Address _____

STATE OF MAINE

_____, SS.

Date: _____

Personally, appeared _____ and acknowledged the foregoing instrument to be his/her free act and deed in his/her capacity and the free act and deed of said company.

Notary Public

Print Name

Commission Expires _____

Addendum Acknowledged:

_____ Date: _____ Initials: _____

_____ Date: _____ Initials: _____

BASE BID FORM

MDOT ITEM	DESCRIPTION	UNIT	QNTY	UNIT COST	TOTAL COST
202.15	Remove Existing Manhole or Catch Basin	EA	1		
202.16	Remove Existing Storm Drain	LF	40		
202.20	Remove Bituminous Concrete Surface	SY	12,300		
202.201	Sawcut Pavement	LF	1,600		
202.203	Pavement Butt Joint	SY	650		
203.20	Common Excavation	CY	8,000		
203.28	Test Pits	EA	1		
304.10	Aggregate Subbase Course – Gravel Type D	TON	7,300		
304.14	Aggregate Base Course Type A	TON	1,600		
304.141	Aggregate Base Course Type A (SW & DW)	TON	800		
403.209	Hot Mix Asphalt – Hand Placed	TON	360		
403.210	Hot Mix Asphalt – 9.5mm Surface	TON	1,150		
403.211	Hot Mix Asphalt – 9.5mm Shim	TON	30		
403.213	Hot Mix Asphalt, 12.5mm Base	TON	1,300		
409.15	Bituminous Tack Coat. Applied	GAL	440		
603.159	12" Culvert Pipe Option III	LF	120		
604.161	Alter Existing CB/MH – Core 6"	EA	9		
604.162	Alter Existing CB/MH – Core 12"	EA	7		
604.18	Adjusting Manhole or Catch Basin to Grade	EA	16		
604.252	Catch Basin Type A5-C	EA	5		
605.09	6" HDPE Underdrain Type B	LF	2,940		
605.11	12" Underdrain Type C	LF	320		
608.26	Pedestrian Ramp with Detectable Warning	SF	412		
609.11	Vertical Curb Type 1 – Granite	LF	1,720		
609.111	Vertical Curb Drainage Inlet	EA	15		
609.12	Vertical Curb Type 1 - Circular	LF	300		
609.234	Terminal Curb Type 1 – 4 Foot – Granite	EA	16		
609.237	Terminal Curb Type 1 – 7 Foot – Granite	EA	21		
609.238	Terminal Curb Type 1 – Circular – 4'	EA	31		
609.239	Terminal Curb Type 1 – Circular – 7'	EA	4		
609.38	Reset Curb Type 1	LF	2,100		
615.08	Loam and Seed	SY	3,200		
626.11	Precast Concrete Junction Box	EA	4		
626.215	2" – Steel Conduit	LF	100		
626.220	2" – No-Metallic Conduit – Schedule 80	LF	100		
626.221	1" - Non-Metallic Conduit -Schedule 40	LF	2,600		
626.222	1" -Non-Metallic Conduit -Schedule 40- 90 ^o	LF	55		
626.371	Foundation Bases	EA	14		
627.75	White Pavement Markings - Crosswalks	SF	850		

634.042	#10 AWG THWN-2 Cable Installation	LF	9,000		
634.08	Electrical Service Box 100 Ampere	EA	1		
634.21	Lighting Standard / luminaries	EA	14		
652.361	Maintenance of Traffic Control	LS	1		
652.381	Traffic Officers	HR	16	\$96.00	\$1,536.00
659.10	Mobilization	LS	1		
Total					

BID ALTERNATE

MDOT ITEM	DESCRIPTION	UNIT	QNTY	UNIT COST	TOTAL COST
830.01	Install 1" CTS Water Main	LF	20		
830.02	Install 1.5" CTS Water Main	LF	20		
830.03	Install 6" PVC Bionax Water Main	LF	60		
830.04	Install 8" PVC Water Main	LF	2,600		
830.05	Install Water Service – Shortside	EA	18		
830.06	Install 1" Water Service – Longside	EA	22		
830.07	Install 8" x 8" T	EA	6		
830.08	Install 8" x 6" MJ Ductile Iron T	EA	2		
830.09	Install 8" x 6" Reducer	EA	6		
830.10	Install 12" x 8" T	EA	1		
830.11	Install Fire Hydrant	EA	1		
830.12	Install 8" Gate Valve	EA	18		
830.13	Install 6" Gate Valve	EA	3		
830.14	Install 2" Blowoff	EA	1		
830.15	Install 1" Air Release Valve	EA	3		
830.16	Install 8" x 1" Tapping Saddle	EA	29		
830.17	Install 8" x 1.5" Tapping Saddle	EA	1		
830.18	Install 8" 45 Degree Coupling	EA	4		
830.19	Install 8" Cast Coupling	EA	2		
830.20	Install Sewer Manhole	EA	2		
830.21	Adjust Water Valves to Grade	EA	25		
830.22	Adjust Curb Stops to Grade	EA	40		
830.23	Adjust Sewer Manholes to Grade	EA	13		
Total					

BASIS OF AWARD BID FORM 2024 RECONSTRUCTION PROJECT AUBURN, ME	
1. BASE BID	\$
2. BID ALTERNATE	\$
GRAND TOTAL	\$

SCOPE OF WORK

The following scope of work is being proposed for the 2024 Reconstruction Project for the City of Auburn. The scope of work is a brief overview of the expected extent of work on each street included in this contract. This is only a proposed scope with associated estimated quantities. Items, extent, and entire streets may be added or deleted as work progresses or to meet the available funding for this work. Reference Appendix A for Water Main Mapping, Appendix B for Reconstruction Plans and Appendix C for Electrical Support Documents.

Fourth Street – Broad Street to Gill Street

- Existing & proposed dimensions: 32' by 1425'
- Box cut the road for typical installation of 15" - Type D, 3" – Type A, 2" 12.5mm base, and 1.5" 9.5mm surface.
- Broad Street to Cook Street section will be raised to improve driveway matches.
- Butt joints shall be constructed at intersections and affected driveways.
- Install 1600' of 8" Water Main from Broad St to Gill St.
- Install 6" UD where instructed.
- Reset existing catch basins/manholes to finish grade.
- Install pedestrian lighting Broad St to Dunn St.
- Reset existing granite curb and set in concrete from Broad St to Gill St.
- Install pedestrian detectable warning surfaces and paint high visibility crosswalks.
- Loam and seed disturbed lawn areas, and esplanades.

Fourth Street – Gill Street to Dead End

- Existing & proposed dimensions: 25' by 215'
- 0.5" Shim with 9.5mm HMA, overlay 1.5" with 9.5mm HMA.
- Remove old catch basin, replace with new.
- Remove old basin lead and cap off pipe.
- Install new 12" HDPE culvert from basin to drainage manhole.
- Install new granite curb behind basin.

Marian Drive – Broad Street to Sherwood Drive

- Existing dimensions: 34' (varies) by 900'
- Proposed dimensions: 34' by 900'
- Box cut the road for typical installation of 15" - Type D, 3" – Type A, 2" 12.5mm base, and 1.5" 9.5mm surface.
- Box cut sidewalk for typical installation of 12" - Type A, 2" 9.5mm surface.
- Box cut sidewalks through typical driveway aprons for installation of 12" - Type A, 2" 12.5mm base and 1" 9.5mm surface.
- Butt joints shall be constructed at intersections.
- Install new drainage infrastructure.
- Install 1000' of 8" Water Main from Sherwood Dr to Broad St.
- Install new granite curbing.
- Install pedestrian detectable warning surfaces and paint high visibility crosswalks.
- Loam and seed disturbed lawn areas.

SPECIAL PROVISIONS

The following Supplemental Specifications and Special Provisions shall amend the "Maine, Department of Transportation Standard Specifications, **March 2020 Edition**" including any and all applicable revisions and special provisions. In case of conflicts, these Supplemental Specifications (1) and Special Provisions (2) shall take precedence and shall govern.

(1) Supplemental Specifications - modifications, additions, and deletions to the existing Standard Specifications.

(2) Special Provisions - specifications in the contract which are for additional items not covered in the Standard Specifications

F-1 Work Hours

No work shall proceed on this project prior to the hour of 7:00 AM or after 7:00 PM (prevailing time) on any working day unless the City has granted prior approval. The definition of work for this specification shall include starting or moving of equipment, machinery, or materials. Any day worked for four hours or more will be considered a full working day.

F-2 Notification of Residents

Residents shall be notified sufficiently in advance of any construction affecting the driveway and sidewalk to allow adequate time for their removal of personal vehicles. Location of cuts for drive access affecting individual residents shall be brought to their attention.

F-3 Traffic Signs

All existing traffic signs, which are to be removed during construction, shall be dismantled and the posts removed and shall be stacked in an area approved by the Project Manager. Contractor

shall protect the signs from damage while in his possession and shall repair, at no additional cost to the City, any damage caused by his operations.

Stop signs are to be maintained at their original locations, at all times during the progress work.

Prior to the start of any construction work, the Contractor shall prepare an acceptable inventory of all signs within the project limits which shall be used as a guide for replacement should signs be removed for construction purposes.

This work shall be considered as a subsidiary obligation of the contract for which no special payment will be made.

F-4 Protection of Trees

The Contractor shall be responsible for the preservation of all trees on the project, which are not to be removed. Any trees damaged by the Contractor's operations shall be repaired as approved by tree dressing or paint in accordance with the appropriate provisions of Section 201 of Standard Specifications.

F-5 Maintenance and Protection of Traffic

The Contractor shall be responsible for the maintenance and protection of all vehicular and pedestrian traffic at all times during construction and shall erect suitable warning signs, flashing barriers or temporary lighting devices of sufficient size and number to afford protection to the traveling public in accordance with the most recent edition of "Manual on Uniform Traffic Control Devices for Streets Highways" published by the Department of Transportation of the Federal Highway Administration.

The Contractor shall be held responsible for all damage to the work due to any failure of the warning devices to properly protect the work from the traffic, pedestrians, or other causes. Traffic control shall be in accordance with the City of Auburn's Traffic Detail Policy effective April 1, 2006.

F-5A Materials

Materials shall meet the requirements specified for the various subsections of the Specifications. Equals shall be approved only prior to the bid opening.

F-6 Survey

The City of Auburn, Department of Engineering will establish, at their discretion, a benchmark location and one construction baseline. The Contractor shall be responsible for maintaining these controls during construction and providing all additional survey required, which shall be done by a competent Engineer or Surveyor.

F-7 Waste Areas

The disposal of waste and surplus material and slash from tree cutting shall be as outlined in Section 203.06 - Waste Areas of the Supplemental Specifications.

F-8 Occupational Safety and Health

The Contractor is hereby advised that all work to be furnished to the City shall be performed with equipment, methods, and use of personnel in conformance with the pertinent Occupational Safety and Health Act requirements of the State of Maine and with the regulations for construction as specified by the Department of Labor and Occupational Safety and Health Administration (OSHA) as currently amended.

F-9 Pre-Construction Conference

A conference will be held at 60 Court Street, Auburn, Maine within ten (10) days after the awarding of the contract. At this time, the Contractor will be required to submit a graphically illustrated schedule and a plan showing project activities. City officials and representatives of the various utility companies involved in the project will be present at this meeting.

It is the purpose of this meeting to inform the various agencies of the proposed work schedule, and to give them the opportunity of discussing any difficulties and of offering suggestions to the Contractor concerning his proposed schedule in order that full cooperation may be reached.

F-10 Schedule of Operations

The above-mentioned schedule of operations in Section F-10 shall consist of a bar chart detailing the activities included in the contract. Although a bar chart is acceptable as a minimum, more complex and detailed schedules (i.e., flow charts, critical paths, etc.) are encouraged and will be accepted by the City. Updates will be required.

F-11 Traffic Officers

Traffic control shall be the responsibility of the Contractor and as directed. Traffic control officers will be employed by the Contractor. Police detail is not anticipated for this project.

F-12 Limitation of Operations

The Contractor shall conduct the work at all times in such a manner and in such sequence as will assure the least interference with traffic. The Contractor shall not open up work to the prejudice or detriment of work already started. The Project Manager may require the Contractor to finish a section on which work is in progress before work is started on any additional sections, if finishing such section is essential to public convenience.

Waste and surplus material shall not be stockpiled but shall be disposed of in areas as designated in Section 203.06, Waste Areas, of the Supplemental Specifications.

F-13 Questions Regarding Plans and Documents

Questions from prospective bidders relative to this Contract shall be submitted no later than five days before bid opening and directed to:

Adam Stevens
Project Manager
Engineering Department
astevens@auburnmaine.gov
Tel. 333-6601 ext. 1140

F-14 Record Drawings

The Contractor shall keep daily records of all changes in the work and records of underground infrastructure. Upon completion of the project, the Contractor shall deliver to the Project Manager copies of daily records. Final payment will not be made until the Project Manager receives copies of daily records. The Contractor **shall** submit as-built mark ups on a scaled GIS sheet detailing stormwater structures and pipes.

F-15 Waste Material

All waste material shall be removed from the site and the area left clean upon completion of work. Any equipment or structures damaged by the Contractor shall be repaired or replaced at no additional cost to the City.

F-16 Quality Assurance

The Contractor shall be responsible at all times for maintaining top quality assurance during the performance of his work.

F-17 Bids

No bids shall be withdrawn within a period of sixty -(60)- days after the opening of the bids.

F-18 Aggregate Base Courses

All gravel products shall meet MDOT specifications and shall also be produced from quarry rock.

F- 19 Pipe Materials

All pipe supplied on this project shall be High Density Polyethylene (HDPE) pipe unless otherwise specified.

F – 20 Sawcut Joints

Joints created by saw-cutting shall be protected prior to paving. Damaged joints will be cut back at no additional cost to the City.

F- 21 Weekly Quantity Reports

The Contractor shall submit weekly electronic reports of daily quantities by the end of the day the following Monday. These reports shall be emailed to astevens@auburnmaine.gov.

F- 22 Change Orders

Changes in the scope of work will be approved by the Project Manager and adjusted by Change Orders.

F-23 Escalation

Raise in escalation shall be forfeited if paving work is performed after the contract completion date. Escalation price at the time of the completion date shall be used for calculating unless the price decreases.

F-24 Water & Sewer Work Materials

Auburn Water and Sewer District is responsible for supplying the materials to the Contractor for the water main and water services proposed work. Upon delivery, the Contractor becomes responsible for the security of said materials. See Appendix A for sewer and water notes.

F-25 Mechanical Sweeping

The City of Auburn shall mechanically sweep the streets prior to placement of surface paving. Hand sweeping, leaf blowing etc. shall be completed by the contractor. Request for sweeping must be made by the Contractor to the City of Auburn at least 72 hours prior to surface paving.

F-26 Junction Boxes

The junction box shall have a 12" by 12" steel cover, the cover sets on a steel angle flange. The box is made of precast concrete with an open bottom, it has an inside dimension of 14" by 14" and is 24" deep.

**SUPPLEMENTAL SPECIFICATIONS
SECTION 100 - GENERAL PROVISIONS**

1. Scope

The work covered by this section includes furnishing all labor, equipment, materials, incidentals, and the performing of all operations in connection with the work encompassed by these contract documents. All work shall be subject to the terms and conditions of the contract documents.

2. Standard Specifications

The City of Auburn, Maine has adopted for this project, the "State of Maine, Department of Transportation, Standard Specifications, **March 2020 Edition**", and the Standard Details (December 2002) and the following Supplemental Specifications including all current additions or modifications thereof. In the case of conflict with the following Supplemental Specifications, addenda shall take precedence and shall govern.

Wherever in the Specifications and in this Contract the term "Department", "the Department of Transportation", "MDOT", or any reference to the "State of Maine, Department of Transportation" or its "Engineers" is mentioned, the intent and meaning shall be interpreted to refer to the CITY OF AUBURN, MAINE, or their authorized representative.

SUPPLEMENTAL SPECIFICATIONS
SECTION 202 - REMOVING OF STRUCTURES AND OBSTRUCTIONS

The provisions of Section 202 of the Standard Specifications shall apply to the following additions and modifications:

202.01 Description

The sawcut item will be used for cutting the match line in driveways and intersections. This work shall consist of the removal of existing manholes and catch basins.

202.06 Removing Bituminous Concrete Pavement

The equipment for removing bituminous pavement shall be capable of scarifying and loading the bituminous pavement without including any gravel, except that adhering to the pavement.

202.07 Method of Measurement

Removing bituminous pavement surface will be measured by the square yard with no deductions made for areas occupied by existing catch basins and manholes.

202.08 Basis of Payment

The accepted quantity of removing pavement surface for butt joints will be paid for at the contract unit price per square yard which price will be full compensation for removing, hauling, clean up and stockpiling the material. The accepted quantity of saw cutting will be paid for at the contract unit price per linear foot which price will be full compensation for cutting, cleaning, and protecting joints prior to paving. The accepted quantity of catch basin or manhole removal will be paid for at the contract unit price per each and will be full compensation for removing at full depth, hauling, clean up and stockpiling the material. **Removal of existing pipe within four feet of the horizontal limits of excavation for a proposed pipe will be considered incidental to that applicable pipe pay item.**

Pay Item		Pay Unit
202.15	Remove Existing Manhole or Catch Basin	Each
202.16	Remove Existing Storm Pipe	Linear Foot
202.20	Remove Bituminous Concrete Surface	Square Yard
202.201	Sawcut Pavement	Linear Foot
202.203	Pavement Butt Joint	Square Yard

**SUPPLEMENTAL SPECIFICATIONS
SECTION 203 – COMMON EXCAVATION**

The provisions of Section 203 of the Standard Specifications shall apply with the following additions and modifications:

203.01 Description

The common excavation item shall be used for box cutting the roadway. Test pits shall be used for locating conflicting utilities with proposed storm drains and structures.

203.19 Basis of payment

The accepted quantity of common excavation will be paid for at the contract unit price per cubic yard which price will be full compensation for removing and hauling the material. The accepted quantity of test pits will be paid for at the contract unit price per each. Payment shall be full compensation for furnishing all labor, materials, and equipment necessary for excavation, backfilling, and surface replacement, disposal of materials, and protection of utilities.

Pay Item		Pay Unit
203.20	Common Excavation	Cubic Yard
203.28	Test Pits	Each

SUPPLEMENTAL SPECIFICATIONS
SECTION 304 – AGGREGATE BASE COURSE

The provisions of Section 304 of the Standard Specifications shall apply with the following additions and modifications.

304.01 Description

Aggregate Base Course Type A and Subbase Course Type D materials **shall** be a crushed product sourced from a quarry. This surface shall be graded with 2% slopes in a normal crowned cross section unless otherwise directed.

Dust Control. The Contractor shall employ dust control measures to minimize the creation of airborne dust during the construction process. As a minimum, standard dust control techniques shall be employed where heavy equipment and the public will be traveling. These may include techniques such as watering-down the site or spreading hygroscopic salts.

304.07 Basis of Payment

The accepted quantities of base course material will be paid for at the respective contract unit price per ton complete in place.

Pay Item		Pay Unit
304.10	Aggregate Subbase Course – Gravel Type D	Ton
304.14	Aggregate Base Course Type A	Ton
304.141	Aggregate Base Course Type A (SW & DW)	Ton

**SUPPLEMENTAL SPECIFICATIONS
SECTION 403 - HOT BITUMINOUS PAVEMENT**

The provisions of Section 403 of the Standard Specifications shall apply with the following additions and modifications.

403.01 Description

This work shall include machine placing HMA as indicated in the Scope of Work. Materials and their use shall conform to the requirements of all related and applicable sections of this contract. HMA shall be placed and compacted with a minimum of two lifts where the total thickness of pavement to be placed exceeds 2". The **most recently** revised special provision Section 108 using the New England Selling Price shall apply to this contract.

403.05 Basis of payment

The accepted quantities of hot mix asphalt pavement will be paid for at the contract unit price per ton for the mixtures, including hot mix asphalt material complete in place.

Pay Item		Pay Unit
403.209	Hot Mix Asphalt – Hand Placed	Ton
403.210	Hot Mix Asphalt – 9.5mm Surface	Ton
403.211	Hot Mix Asphalt – 9.5mm Shim	Ton
403.213	Hot Mix Asphalt - 12.5mm Base	Ton

**SUPPLEMENTAL SPECIFICATIONS
SECTION 409 - BITUMINOUS TACK COAT**

The provisions of Section 409 of the Standard Specifications shall apply with the following additions and modifications.

409.07 Application of bituminous material

The rate of application shall be 0.03 gallons per square yard as directed. During application, care shall be taken to assure areas outside of the work area shall not be discolored. Tack coat shall be required between all layers of Hot Mix Asphalt.

409.09 Basis of payment

The accepted quantity of bituminous tack coat will be paid for at the contract unit price per gallon for the designated type of material complete in place.

Pay Item	Pay Unit
409.15 Bituminous Tack Coat. Applied	Gallon

SUPPLEMENTAL SPECIFICATIONS
SECTION 603 - PIPE CULVERTS AND STORM DRAINS

The provisions of Section 603 of the Standard Specifications shall apply with the following additions and modifications.

603.01 Description

This work shall consist of installing conveyance storm drain at locations specified on the plans and as directed.

603.02 Materials

All pipe shall be High Density Polyethylene (HDPE) and equal to or larger than the existing pipe.

603.12 Basis of Payment

The accepted quantity of culvert pipe will be paid for at the contract unit price per linear foot. This price shall include the **cost of excavation**, all labor, materials, and equipment necessary to install the storm drains.

Pay Item	Pay Unit
603.159 12" Culvert Pipe Option III	Linear Foot

**SUPPLEMENTAL SPECIFICATIONS
SECTION 604 – CATCH BASINS**

The provisions of Section 604 of the Standard Specifications shall apply with the following additions and modifications.

604.01 Description

Construct manholes, inlets and catch basins. New catch basins shall be priced for a minimum of three inverts. Additional inverts, if required, shall be paid separately. Existing catch basins and manholes will need coring for connection of proposed underdrains and storm drains. New connections to existing pipe shall be incidental to the structure item.

Adjust existing manholes (storm drains) to grade.

604.06 Basis of Payment

The accepted quantities of catch basins and manholes will be paid for at the contract unit price complete in place. The accepted quantities of altering existing catch basin and manhole adjustments to grade will be paid for at the contract unit price each. The accepted quantity for coring into existing catch basin and manhole will be paid for at the contract unit price each.

Pay Item	Pay Unit
604.161 Alter Existing CB/MH – Core 6"	Each
604.162 Alter Existing CB/MH – Core 12"	Each
604.18 Adjusting Manhole or Catch Basin to Grade	Each
604.252 Catch Basin Type A5-C	Each

**SUPPLEMENTAL SPECIFICATIONS
SECTION 605 – UNDERDRAINS**

The provisions of Section 605 of the Standard Specifications shall apply with the following additions and modifications.

605.01 Description

This work shall consist of installing underdrain using pipe and filter material and pipe outlets in accordance with Maine DOT Standard Specification Subsection 605.04. Connect underdrains to upgradient structures where possible for future maintenance access.

605.02 Materials

All pipe shall be High Density Polyethylene (HDPE) and equal to or larger than the existing pipe. Pipe backfill shall meet Maine DOT Standard specifications Subsection 703.22 Underdrain Backfill. **6" Underdrain shall be perforated with a soil filter sock.**

605.07 Basis of Payment

The accepted quantity of underdrain will be paid for at the contract unit price per linear foot. This price shall include the **cost of excavation**, all labor, materials, and equipment necessary to install the underdrain. Pipe fittings shall be considered part of the linear footage.

Pay Item		Pay Unit
605.09	6" Underdrain Type B	Linear Foot
605.11	12" Underdrain Type C	Linear Foot

SUPPLEMENTAL SPECIFICATIONS
SECTION 608 – PEDESTRIAN RAMP WITH DETECTABLE WARNING SURFACE

The provisions of Section 608 of the Standard Specifications shall apply with the following additions and modifications.

608.01 Description

This item shall consist of constructing the concrete portion of the sidewalk ramp at an intersecting street. The bid price shall include all necessary work to install concrete (precast acceptable) and truncated domes. Work shall follow Section 608 of MDOT Standard Details, March 2020 edition and current ADA specifications.

608.05 Method of Measurement

Detectable warning plates will be measured for payment by the square foot of actual plate area, only, not including the surrounding concrete.

608.06 Basis of Payment

The accepted quantity of pedestrian ramps with detectable warning surface will be paid for at the contract unit price per square foot and **shall include concrete and cast-iron truncated dome.**

Pay Item	Pay Unit
608.26 Pedestrian Ramp with Detectable Warning Surface	Square Foot

**SUPPLEMENTAL SPECIFICATIONS
SECTION 609 - CURB**

The provisions of Section 609 of the Standard Specifications shall apply with the following additions and modifications.

609.01 Description

This item consists of the installation of granite curb. Granite curb shall be backfilled front and back and under with concrete up to HMA base course elevation. Curb reset item is for the roads in the Base Bid to reset in place.

609.02 Materials

Granite curbing, which contains pink quarts (Caledonia Type), shall not be used on this project. All granite curbing shall be predominately gray in color.

A mix design for the Portland Cement Concrete shall be submitted to the City. Concrete shall be used for the base for the curb with a minimum designed compressive strength of 1,500 psi.

609.10 Basis of Payment

The accepted quantities of vertical granite and radial granite curb will be paid for at the contract unit price linear foot complete in place. Drainage inlets and terminal curb items will be paid for at the contract unit price per each in place. **The reset curb type 1 price shall include the costs associated with removal of the curb.**

Pay Item	Pay Unit
609.11 Vertical Curb Type 1 – Granite	Linear Foot
609.111 Vertical Curb Drainage Inlet	Each
609.12 Vertical Curb Type 1 - Circular	Linear Foot
609.234 Terminal Curb Type 1 – 4 Foot – Granite	Each
609.237 Terminal Curb Type 1 – 7 Foot – Granite	Each
609.238 Terminal Curb Type 1 – Circular 4'	Each
609.239 Terminal Curb Type 1 – Circular 7'	Each
609.38 Reset Curb Type 1	Linear Foot

**SUPPLEMENTAL SPECIFICATIONS
SECTION 615 - LOAM**

615.01 – Description

This work shall consist of loaming and seeding areas adjacent to existing lawn areas or as required. Loam and its applications shall conform to the requirements of Section 615 of the Standard Specifications. Loam shall have a **finished depth of six (6") inches** and shall be screened through a one (1") inch square mesh screen. Loam areas shall be rolled (compacted) prior to placement of seed and mulch.

Seeding shall be Method Number 1 and shall conform to the requirements of Section 618 of the Standard Specifications. The Contractor shall be required to continually seed area of loam and seed until a satisfactory growth of grass is established. If so required, all areas to be loamed and seeded shall be mulched with an approved wood cellulose fiber compatible with recommended hydro-seeding practices. This mulch shall be applied simultaneously with the seed and shall be of sufficient quantity to protect the seed and hold moisture in to insure a satisfactory growth of grass.

The specifications for the wood cellulose fiber proposed to be used shall be presented to the Project Manager for acceptance at least ten (10) days (working days) prior to the application thereof.

The Contractor shall also be responsible for mowing any and all areas loamed and seeded. The mowing will be required if deemed necessary to insure and maintain a satisfactory growth of grass and shall not exceed two mowing's.

615.02 – Materials

After a sample of loam has been submitted to the Project Manager, he may require that a sample be submitted to a testing agency to determine its organic content, characteristics, and potential use as loam suited to the site. Loam shall meet the required 5 percent minimum organic content prior to placement.

615.08 – Basis of Payment

The accepted quantity of loam and seed will be paid for at the contract **unit price per square yard for a successful growth of grass**. This price shall include the cost of excavation and all labor, materials, and equipment necessary to satisfactorily complete the work. All costs for watering, furnishing labor and equipment for mowing will not be paid for separately, but shall be considered as incidental to this pay item.

Pay Item	Pay Unit
615.08 Loam and Seed	Square Yard

SUPPLEMENTAL SPECIFICATIONS
SECTION 626 – FOUNDATIONS, CONDUIT, AND JUNCTION BOXES FOR HIGHWAY
SIGNING, LIGHTING AND SIGNALS

The provisions of Section 626 of the Standard Specifications shall apply with the following additions and modifications.

626.01 Description

This work shall consist of furnishing, installing concrete foundations and conduit for highway lighting.

626.02 General

Installation of electrical service conduit methods and locations shall be approved by the Auburn City Electrician.

626.021 Materials

Materials shall meet the requirements specified in the following Subsection of Division 700 - Materials:

Reinforcing Steel	709.01
Steel Conduit	715.02
Non-Metallic Conduit	715.03

1" inch conduit underground shall be provided in light pole bases. Each light shall be fused individually at base. Fuse holder type shall be Buchanan 65 kit Cat # 65U. 20 ampere fuse to be included for each base.

**WFCL2 P40 40K MVOLT FC *X BK SK AO FPD70 WDA 12 FTJ 17D C03 BK ABG RP138A
FGIUS BK ASSY 2763**

Utility Washington Series Luminaire Full Cutoff LED2, P40 performance package, 4000K, 120-277V, Full cutoff, type II, Black, Spike finial, Field adjustable lumen output, Factory programmed to 70 percent of base wattage, Wadsworth aluminum pole, 12 feet, Fluted tapered, .25 wall thickness, 17" Base, Diamond Pattern Bolt Circle, Tenon, 3.00 O.D. x 3" tall, Black, Anchor bolt (galvanized steel), Receptacle with small, in-use wet location cover, Black. **(SUBMITTALS REQUIRED PRIOR TO ORDER)**

***X- Photometric study to be performed by Holophane representative prior to bid award. This will not add cost to the City or Contractor.**

626.03 Construction foundations

Coordinate excavation for foundations with existing underground utilities. Where conflicts are

found with existing utilities, make all practical efforts to install new work to produce a minimum impact on existing conditions. Where relocation of existing utilities is deemed necessary, obtain approval from affected utility supplier in advance of commencing relocation work.

626.034 Concrete foundations

Anchor bolts for new lighting poles shall be of size and diameter as required and as detailed on the Contract Drawings.

626.04 Method of measurement

Provision of new foundations will be measured by the single unit, including concrete and steel reinforcing. Steel and non-metallic conduit will be measured per linear foot. Junction boxes will be measured by each unit.

626.05 Basis of payment

The accepted quantity of new foundations will be paid for at the contract unit price for each foundation. Payment shall be full compensation for the complete installed foundation. Payment will be made for the total number of linear feet of each type of underground conduit furnished, installed, and accepted at the contract unit price per linear foot. This price shall include the cost of furnishing and installing the conduit; pull wire; fittings; labor; equipment and incidentals necessary to complete the work including concrete encasement.

Pay Item	Pay Unit
626.11 Precast Concrete Junction Box	Each
626.215 2" – Steel Conduit	Linear Foot
626.220 2" – Non-Metallic Conduit – Schedule 80	Linear Foot
626.221 1" Non-Metallic Conduit -Schedule 40	Linear Foot
626.222 1" Non-Metallic Conduit -Schedule 40 - 90°	Each
626.371 Foundation Bases	Each

**SUPPLEMENTAL SPECIFICATIONS
SECTION 627 – PAVEMENT MARKINGS**

The provisions of Section 627 of the Standard Specifications shall apply with the following additions and modifications.

627.01 Description

This item shall consist of furnishing and placing reflectorized pavement markings in accordance with Section 708.03 and Section 712.05. This item is used for painting high visibility crosswalks and stop bars.

627.10 Basis of payment

Pavement markings will be paid for at the contract unit price per square foot.

Pay Item		Pay Unit
627.75	White Pavement Markings	Square Foot

SUPPLEMENTAL SPECIFICATIONS
SECTION 634 – HIGHWAY LIGHTING

The provisions of Section 634 of the Standard Specifications shall apply with the following additions and modifications.

634.01 Description

This work shall consist of furnishing and installing new lighting poles with fixed luminaires with individual branch circuits and wiring for receptacle outlets at each luminaire. All branch circuits shall be derived from the existing electrical control cabinet located on Dunn Street.

634.02 General

Lighting poles shall be provided in locations detailed on the Construction Plans. Power connection for new lighting poles shall be obtained by a new metered service contracted with the Central Maine Power Company. Luminaires shall be "Utility Washington Postlite" style decorative luminaires as manufactured by Holophane Lighting, rated to operate 47-watt LED lamps.

634.021 Materials

Materials shall meet the requirements specified in the following Subsection of Division 700 - Materials:

Secondary Wiring	709.01
Luminaires, Lamps, and Ballasts	715.02
Photo-Electric Control	715.03
Anchor Bolts	720.07
Lighting Control Box	715.11

634.024 Light Standards

Light standards shall be as furnished by the Holophane Lighting and shall be 12-foot tall, round aluminum, with polyester powder coat black paint finish. Light Standards shall be equipped with a duplex GFIC weatherproof receptacle outlet mounted at 11'-0".

634.04 Cable Installation

All cable servicing lighting poles shall be furnished and installed under this contract. The Contractor shall furnish and install cable and shall make connections at the base of poles to underground service cables.

634.06 Luminaires

Luminaires as furnished by Holophane Lighting shall include polyester powder coat black paint finish. Luminaires shall provide an IESNA Type 3 optical distribution.

Luminaire & lighting standards:

Note 1-WFCL2 P40 40K MVOLT FC *X BK SK AO FPD70 WDA 12 FTJ 17D C03 BK ABG RP138A FGIUS BK ASSY 2763

Utility Washington Series Luminaire Full Cutoff LED2, P40 performance package, 4000K, 120-277V, Full cutoff, type II, Black, Spike finial, Field adjustable lumen output, Factory programmed to 70 percent of base wattage, Wadsworth aluminum pole, 12 feet, Fluted tapered, .25 wall thickness, 17" Base, Diamond Pattern Bolt Circle, Tenon, 3.00 O.D. x 3" tall, Black, Anchor bolt (galvanized steel), Receptacle with small, in-use wet location cover, Black. (installation voltage 240vac single phase). **(SUBMITTALS REQUIRED PRIOR TO ORDER)**

***X- Photometric light pattern type to be determined by Holophane representative prior to bid award. This will not add additional cost to the City or Contractor.**

634.08 Electrical Service:

The utility service shall be rated 100 ampere-120/240 VAC, single phase, 3-wire. The following equipment shall be provided and installed at the service location:

1-Weatherproof NEMA 3R control cabinet (Cat. APXTC503017 with 15" extension) containing the following equipment:

Cabinet mounted combination service meter with main service disconnect (Milbank U3989XL100) including an exterior mounted service duplex receptacle and metallic in-use cover.

Square D load center- QO124L125PG with QOC24US cover surface cover.

3- Two-pole 30 Ampere QO breakers for lighting branch circuits.

6-Single-pole QO 20 Ampere breakers.

1-Concrete base sized to support control cabinet.

Note #2-Lighting Controls:

2 – Electrical and Electronic Controls (cat. No. LS11K-22-AL-HOA) self-contained lighting contractor with Hand-Off-Auto Selector switch.

2 – Tork photo control (1/2" Stem & Swivel Pencil, On 1-5fc/Off 3-15fc, 6" Leads, 120V, 2000W Tungsten, 1800VA Ballast, 600VA LED) or equivalent.

Lighting circuits shall operate dusk to dawn with additional Hand-Off-Auto control.

Receptacle circuits shall operate dusk to dawn with additional Hand-Off-Auto control.

The location of the service equipment and cabinet foundation shall be field verified prior to construction. All miscellaneous fittings and equipment necessary to complete the electrical

service and branch circuit distribution shall be included in the bid price.

All equipment and electrical installations shall meet NFPA 70- 2023 edition.

634.092 Method of Measurement

New light standards will be measured by the single unit, complete in place and accepted, including luminaires, lamps, poles, breakaway devices, internal wiring, and anchor bolts.

New electrical service boxes shall be measured as a single quantity, complete and accepted, including all interior components.

634.093 Basis of Payment

The accepted quantity of light standards will be paid for at the contract unit price each for the number of standards by each type. Payment shall be full compensation for the light poles, pole bracket arms, breakaway devices, pole wiring, luminaires including drivers and lamps, and all incidentals necessary to complete the work.

The accepted quantity of service arrangements will be paid for at the contract unit price for each service box location. Payment shall be full compensation for the service wire, box enclosures, box foundation base, panel boards, photocell controls, contactors, service meter, and all incidentals necessary to complete the work.

Payment will be made for the total number of linear foot of each type of wiring cables actually furnished, installed, and accepted at the contract unit price per unit price. This price shall include the cost of furnishing and installing wiring conductors, terminations, labor, equipment and incidentals necessary to complete the work.

Pay Item	Pay Unit
634.042 #10 AWG THWN-2 Cable Installation	Linear Foot
634.08 Electrical Service Box 100 Ampere	Each
634.21 Conventional Lighting Standard/Luminaries	Each

**SUPPLEMENTAL SPECIFICATIONS
SECTION 652 – MAINTENANCE OF TRAFFIC**

The provisions of Section 652 of the Standard Specifications shall apply with the following additions and modifications.

652.3.6 Traffic Control

The Contractor shall maintain access to all drives during construction. Road closures by block shall be approved by the Project Manager. Two-way traffic flow shall be required on all streets during non-working hours.

The Contractor must submit a written Traffic Control Plan before the Preconstruction Meeting to the Project Manager for approval.

652.7 Method of Measurement

This subsection shall be amended by the addition of the following paragraph:

Maintenance Traffic Control shall be measured as a percentage of work completed to date relative to total work estimated.

652.02 Basis of payment

This subsection shall be amended by the addition of the following paragraph:

Preparation of traffic control plans, constructions signage, barrels, cones, barriers, maintenance of traffic control devices, flaggers, and other necessary incidentals to maintain traffic in accordance with the specifications and the MUTCD shall be paid for Lump Sum under item 652.391 Maintenance of Traffic Control.

Pay Item	Pay Unit
652.361 Maintenance of Traffic Control	Lump Sum
652.381 Traffic Officers	Hourly

**SUPPLEMENTAL SPECIFICATIONS
SECTION 659 – MOBILIZATION**

The provisions of Section 659 of the Standard Specifications shall apply with the following additions and modifications.

659.01 Description

This item shall consist of preparatory work and operations including, but not limited to those necessary to the movement of personnel, equipment, supplies and incidentals to the project site; and for all other work and operations which must be performed, or costs incurred prior to beginning work on the various items on the project site.

659.02 Basis of payment

Partial payments will be made in accordance with Section 108.2.3 Mobilization of the Standard Specifications.

Pay Item	Pay Unit
659.10 Mobilization	Lump Sum

SUPPLEMENTAL SPECIFICATIONS
SECTION 830 – SEWER/WATER MAIN SERVICES

830.01 Description

All connections shall be made in conformance with the Maine State Plumbing Code. All new service lines shall match the size of the existing lines unless other specifically directed by the Auburn Water and Sewerage District. The Contractor shall install locating/warning tape over the water service as required by City ordinance. The Contractor shall provide all necessary labor, equipment, tools, and materials necessary to complete the water service replacements as directed by the Auburn Water and Sewerage District.

The Contractor shall coordinate and attend a Pre-Construction meeting with the Auburn Water and Sewer District and provide all necessary notifications to the District and the City during construction. Fire hydrant location will be determined in the field as directed.

830.02 Removing Material

All water main and services piping, fitting, tracer wire, bends, tees, valves, curb stops, and service boxes materials will be furnished by the Auburn Water and Sewerage District. Thrust blocks shall be supplied by the Contractor. Water mains will be Bionax PVCO Pressure Pipe and a specification for the material is provided in Appendix B.

Backfill and bedding materials shall be provided by the Contractor and shall be considered incidental to the applicable pay items.

830.03 Method of Measurement

Water mains shall be measured per linear foot along the centerline of the pipe, complete in place. Tees and gate valves shall be measured by each unit installed, complete in place. Water services shall be measured by each unit installed, complete in place. Fire Hydrants shall be measured by each unit installed, complete in place.

830.04 Basis of Payment

The accepted quantities of water mains installation shall be paid for at the contract unit price per linear foot, complete in place. Payment shall constitute full compensation for; laying and jointing of piping and appurtenances furnished by the Auburn Water and Sewer District; excavation, shoring and bracing, dewatering; removal and disposal of existing piping and appurtenances; furnishing and placing bedding, backfilling; installing tracer wire; and all labor, equipment, tools, and any other incidentals necessary to complete the work.

The accepted quantities of hydrants, tees, and gates valves installation shall be paid for at the contract unit price per each complete in place. Removal of existing hydrants is incidental to the pay item. Payment shall constitute full compensation for; installation of hydrants, tees and gate

valves furnished by the Auburn Water and Sewerage District; excavation, shoring and bracing, dewatering; removal and disposal of existing piping and appurtenances; furnishing and placing bedding, backfilling; and all labor, equipment, tools, and any other incidentals necessary to complete the work. Thrust blocks shall be furnished and installed by the Contractor.

The accepted quantities of water services installation shall be paid for at the contract unit price per each complete in place. Payment shall constitute full compensation for; installation of piping, service boxes and curb stops furnished by the Auburn Water and Sewerage Districts; excavation, shoring and bracing, dewatering; removal and disposal of existing piping and appurtenances; connection to existing service, furnishing, and placing bedding, backfilling; and all labor, equipment, tools and any other incidentals necessary to complete the work.

The adjustment of new curb stops and gates to grade shall be considered incidental to the contract and shall not require payment. Adjustment of existing curb stops and gates to remain shall be completed by the Auburn Water and Sewerage District.

Pay Item		Pay Unit
830.01	Install 1" CTS Water Main	Linear Foot
830.02	Install 1.5" CTS Water Main	Linear Foot
830.03	Install 6" PVC Bionax Water Main	Linear Foot
830.04	Install 8" PVC Bionax Water Main	Linear Foot
830.05	Install Water Service – Shortside	Each
830.06	Install Water Service - Longside	Each
830.07	Install 8" x 8" "T"	Each
830.08	Install 8" x 6" MJ Ductile Iron "T"	Each
830.09	Install 8" x 6" Reducer	Each
830.10	Install 12" x 8" "T"	Each
830.11	Install Fire Hydrant	Each
830.12	Install 8" Gate Valve	Each
830.13	Install 6" Gate Valve	Each
830.14	Install 2" Blowoff	Each
830.15	Install 1" Air Release Valve	Each
830.16	Install 8" x 1" Tapping Saddle	Each
830.17	Install 8" x 1.5" Tapping Saddle	Each
830.18	Install 8" 45 Degree Coupling	Each
830.19	Install 8" Cast Coupling	Each
830.20	Install Sewer Manhole	Each
830.21	Adjust Water Valves to Grade	Each
830.22	Adjust Curb Stops to Grade	Each
830.23	Adjust Sewer Manholes to Grade	Each

BID BOND

KNOW ALL BY THESE PRESENTS, that we, the undersigned, _____ as Principal, and _____ as Surety, are hereby held and firmly bound unto _____ as OWNER in the penal sum of _____ for payment of which, well and truly to be made, we hereby jointly and severally bind ourselves, successors and assigns.

Signed, this _____ day of _____, 2024.

The Condition of the above obligation is such that whereas the principal has submitted to _____ a certain BID,

attached hereto and hereby made a part hereof to enter into a contract in writing, for the _____

NOW, THEREFORE,

- (a) If said BID shall be rejected, or
- (b) If said BID shall be accepted and the Principal shall execute and deliver a contract in the Form of Contract attached hereto (properly completed in accordance with said BID) and shall furnish a BOND for his faithful performance of said contract, and for the payment of all persons performing labor or furnishing materials in connection therewith, and shall in all other respects perform the agreement created by the acceptance of said BID,

then this obligation shall be void, otherwise the same shall remain in force and effect; it being expressly understood and agreed that the liability of the Surety for all and all claims hereunder shall, in no event, exceed the penal amount of this obligation as herein stated.

The Surety, for value received, hereby stipulates, and agrees that the obligations of said Surety and its BOND shall be in no way impaired or affected by any extension of time within which the OWNER may accept such BID; and said Surety does hereby waive notice of any such extension.

IN WITNESS WHEREOF, the Principal and the Surety have hereunto set their hands and seals, and such of them as are corporations have caused their corporate seals to be hereto affixed and these presents to be signed by their proper officers, the day and year first set forth above.

_____ (L.S)
Principal

Surety

By: _____

IMPORTANT - Surety companies executing BONDS must appear on the Treasury Department's most current list (Circular 570 as amended) and be authorized to transact business in the state where the project is located.

SAMPLE AGREEMENT

THIS AGREEMENT is made this ### day of Month Year, by and between the CITY OF AUBURN, a municipal corporation existing under the laws of the State of Maine and located in the County of Androscoggin, State of Maine (hereinafter "CITY"), Company Name, Address, EIN, (hereinafter "CONTRACTOR"),

WITNESSETH:

In consideration of the mutual covenants and conditions contained herein, the CITY and the CONTRACTOR agree as follows:

SPECIFICATIONS:

1. The CONTRACTOR shall furnish all of the material and perform all of the work shown on the drawings and described in the specifications entitled: Bid # XXXXX Bid Title which are attached hereto and made a part hereof, and the CONTRACTOR covenants that it shall do everything required by this Agreement, the Special Provisions of the Agreement, the Invitation to Bid and the Specifications in return for payment as provided herein.

COMPLETION DATE:

2. The work to be performed under this Agreement shall be commenced by Month day, year and fully completed on or before Month day, year.

CONTRACT PRICE:

3. The CITY shall pay the CONTRACTOR for the performance of the Agreement the sum of \$XXX

PERFORMANCE BOND:

4. If required by the City, the CONTRACTOR shall furnish to the CITY at the time of the execution of this Agreement a performance bond and a labor and material payment bond each in the amount of \$Dollar amount or N/A (whichever applies) executed by a surety company satisfactory to the CITY, guaranteeing the performance and payment by the CONTRACTOR. Yes, Required (Initials: ___) No, Waived (Initials ___)

GUARANTEE:

5. The CONTRACTOR shall guarantee his work against any defects in workmanship and materials for a period of one year from the date of the CITY's written acceptance of the project.

PERMITS AND LICENSES:

6. Permits and licenses necessary for the prosecution of the work shall be secured and paid for by the CONTRACTOR.

CITY'S RIGHT TO TERMINATE CONTRACT:

7. If the CONTRACTOR should be adjudged a bankrupt, or if it should make a general assignment for the benefit of creditors, or if a receiver should be appointed on account of its insolvency, or if it should persistently or repeatedly refuse or should fail, except in cases for which extension of time is provided, to supply enough properly skilled workmen or proper materials, or if it should fail to make prompt payment to subContractors or for material or labor, or persistently disregard laws, and ordinances, or otherwise be guilty of a substantial violation of any provision of the Agreement, then the CITY when sufficient cause exists to justify such action, may, without prejudice to any other right or remedy and after giving the CONTRACTOR, and his surety, seven (7) days written notice, terminate the employment of the CONTRACTOR and take possession of the premises and of all materials, tools and appliances thereon and finish the work by whatever method it may deem expedient. In such case the CONTRACTOR shall not be entitled to receive any further payment until the work is finished. If the unpaid balance of the Agreement price shall exceed the expense of the finishing the work, including compensation for additional architectural, managerial, and administrative services, such excess shall be paid to the CONTRACTOR. If such expense shall exceed such unpaid balance, the CONTRACTOR shall pay the difference to the CITY.

CONTRACTOR'S LIABILITY INSURANCE:

8. The CONTRACTOR shall not commence work under this Agreement until he has obtained all insurance required under this paragraph and such insurance has been approved by the CITY, nor shall the CONTRACTOR allow any subcontractor to commence work on his subcontract until all similar insurance required of subcontractor has been so obtained and approved. It is a requirement that the CITY be named as an Additional Insured on the General Liability and Automobile Liability policies.

Commercial General Liability to include products and completed operations, and blanket contractual. The limits of liability shall be as follows:

Bodily Injury and Property Damage	\$1,000,000
Personal Injury and Advertising Injury	\$1,000,000
Per Project Aggregate	\$1,000,000
General Aggregate	\$2,000,000
Products and Completed Operations Aggregate	\$2,000,000
Medical Payments	\$10,000

(b) Business Automobile Liability

The CONTRACTOR shall maintain and cause all sub-Contractors and lower tier Contractors to maintain business automobile liability insurance covering all owned non-owned, leased, rented or hired automobiles (symbol 1). The limits of liability shall be as follows:

Bodily Injury and Property Damage	\$1,000,000
-----------------------------------	-------------

Automobile physical damage coverage shall be at the option of the CONTRACTOR, all sub-Contractors, and lower-tier Contractors. The CITY shall not be liable for physical loss or damage to any owned, non-owned, leased, rented, or hired automobile.

Workers' Compensation Insurance

The CONTRACTOR shall maintain and cause all sub-Contractors and lower tier Contractor's to maintain Workers' Compensation and Employers Liability in accordance with the laws and regulations of the State of Maine. The limits of liability provided shall be as follows:

Coverage A:	Statutory
Coverage B:	\$100,000/\$500,000/\$100,000

Professional Liability

If the CONTRACTOR is an Architect, Engineer or Surveyor, they shall maintain a policy of insurance to pay on their behalf whatever amounts that may become legally required to pay on account of an error, omission or negligent act.

Limits of Liability shall be as follows:

\$1,000,000 per occurrence and in the aggregate site specific.

It is a requirement that this policy be maintained for a period of three (3) years following completion of the project.

Certificates of Insurance of the types and in the amounts required shall be delivered to the CITY prior to the commencement of any work by the CONTRACTOR, subContractor or lower tier Contractor or any person or entity working at the direction or under control of the CONTRACTOR. The CONTRACTOR shall assume the obligation and responsibility to confirm insurance coverage for all sub-Contractors or lower tier Contractors who will participate in the project.

The Certificate of Insurance and the policies of insurance shall include a sixty (60) day notice to the CITY of cancellation, non-renewal or material change in coverage or form.

The CONTRACTOR and his surety shall indemnify and save harmless the CITY, his officers and employees from all suits, actions or claims of any character brought because of any injuries or damage received or sustained by any person, persons or property on account of the operations of the said CONTRACTOR; or on account of or in consequence of any neglect in safeguarding the work; or through use of unacceptable materials in construction of the work; or because of any act or omission, neglect, or misconduct of said CONTRACTOR; or because of any claims or amounts recovered from any infringements or patent trademark, or copyright; or from any claims or amounts arising or recovered under the "Workmen's Compensation Act" or of any other law, ordinance, order or decree; and so much of the money due to the said CONTRACTOR under and by virtue of his/her contract as shall be considered necessary by the CITY for such purpose, may be retained; or in case no money is due, his surety may be held until such suit or suits, action or actions, claim or claims, for injuries or damages as aforesaid shall have been settled and suitable evidence to that effect furnished to the CITY.

Waiver of Subrogation

Payment of any claim or suit including any expenses incurred in connection therewith by the CITY, or any insurance company on behalf of the CITY shall not constitute a waiver of subrogation against the CONTRACTOR, sub-Contractors or any lower tier Contractor in the event that such claim or suit was caused by or contributed to as a result of the negligent acts of the CONTRACTOR, any sub-Contractors or lower tier Contractors.

Construction Agreement

The CONTRACTOR shall and does hereby agree to indemnify, save harmless and defend the CITY from the payment of any sum or sums of money to any person whomsoever on account of claims or suits growing out of injuries to persons, including death, or damages to property, caused by the CONTRACTOR, his employees, agents or sub-Contractors or in any way attributable to the performance and execution of the work herein contracted for, including (but without limiting the generality of the foregoing), all claims for service, labor performed, materials furnished, provisions and suppliers, injuries to persons or damage to property, liens, garnishments, attachments, claims, suits, costs, attorney's fees, costs of investigation and defense. It is the intention of this paragraph to hold the CONTRACTOR responsible for the payment of any and all claims, suits, or liens, of any nature character in any way attributable to or asserted against the CITY, or the CITY and the CONTRACTOR, which the City may be required to pay. In the event the liability of the CONTRACTOR shall arise by reason of the sole negligence of the CITY and/or the sole negligence of the CITY's agents, servants or employees, then and only then, the CONTRACTOR shall not be liable under the provisions of this paragraph.

DAMAGES:

9. The CONTRACTOR shall defend, indemnify and save harmless the CITY and all persons acting for or on behalf of it against all claims for injuries (including death), loss or damage, arising out of the performance out this contract.

LIENS:

10. Neither the final payment nor any part of the retained percentage shall become due until the CONTRACTOR, if required, shall deliver to the CITY a complete release of all liens arising out of the Agreement, or receipts in full in lieu thereof and, if required in either case, an affidavit that so far as it has knowledge or information the releases and receipts include all the labor and material for which a lien could be filed; but the CONTRACTOR may, if any SUB-CONTRACTOR refuses to furnish a release or receipt in full, furnish a bond satisfactory to the CITY to indemnify it against any lien. If any lien remains unsatisfied after all payment are made, the CONTRACTOR shall refund to the CITY all moneys that the latter may be compelled to pay in discharging such a lien, including all costs and a reasonable attorney's fee.

ASSIGNMENT:

11. Neither party to the Agreement shall assign the Agreement or sublet it as a whole without the written consent of the other, nor shall the CONTRACTOR assign any moneys due or to become due to it hereunder, without the previous written consent of the CITY.

SUBCONTRACTS:

12. The CONTRACTOR shall not sublet any part of this Agreement without the written permission of the CITY. The CONTRACTOR agrees that it is as fully responsible to the CITY for the acts and omissions of its SUB-CONTRACTORS and of persons either directly or indirectly employed by them, as it is for the acts and omissions of persons directly employed by it.

USE OF PREMISES:

13. The CONTRACTOR shall confine its apparatus, the storage of materials and operations of its workers to limits indicated by law, ordinance and permits and shall not otherwise unreasonably encumber the premises with its materials. If any part of the project is completed and ready for use, the CITY may, by written and mutual consent, without prejudice to any of its rights or the rights of the CONTRACTOR, enter in and make use of such completed parts of the project. Such use or occupancy shall in no case be construed as an acceptance of any work or materials.

CLEANING UP:

14. The CONTRACTOR shall at all times keep the premises free from accumulation of waste materials or rubbish caused by its employees or work, and at the completion of the work it shall remove all its rubbish from and about the project, and all its tools, scaffolding and surplus materials and shall leave its work "broom-clean" or its equivalent, unless more exactly specified. In case of dispute, the CITY may remove the rubbish and charge the cost to the CONTRACTOR.

PAYMENTS:

15. Unless otherwise agreed to, the CITY shall make payments on account of the Agreement as follows:

Within 30 days, as invoices are submitted for work completed to the satisfaction of the CITY.

IN WITNESS WHEREOF, the parties hereto have executed this Agreement on the day and year first above written.

BY: _____
Witness

BY: _____
Finance Director

BY: _____
Witness

BY: _____
Contractor

APPENDIX A

AUBURN WATER/SEWER DISTRICT DOCUMENTS

FOURTH ST - BROAD ST TO GILL ST 6" CI WATER MAIN REPLACEMENT

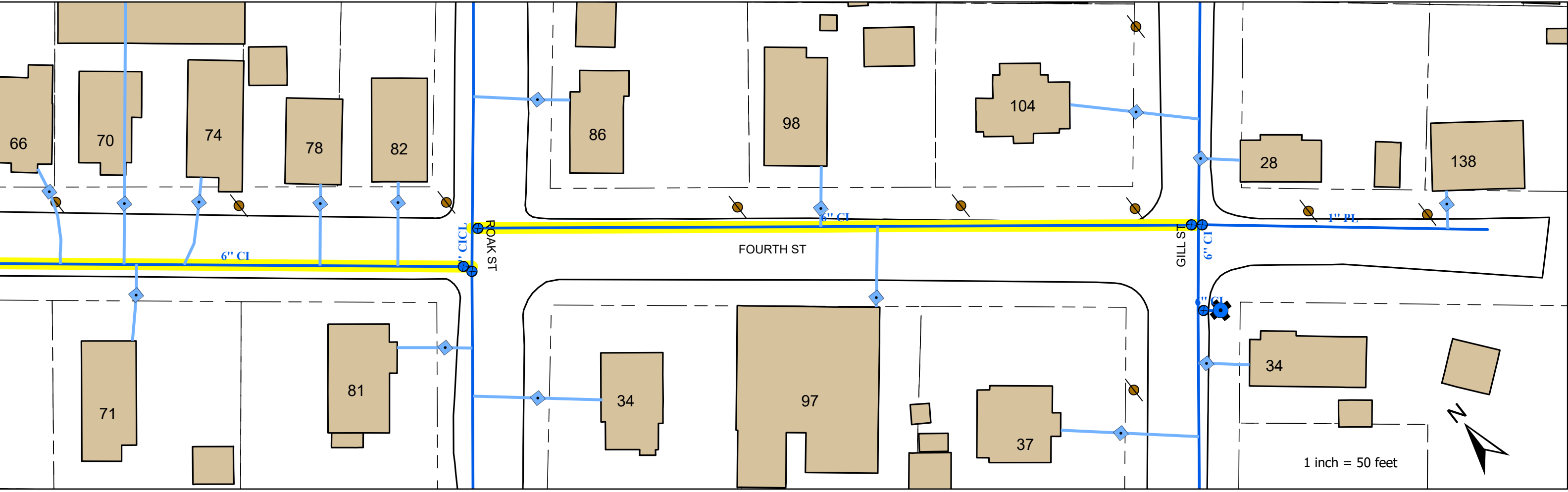
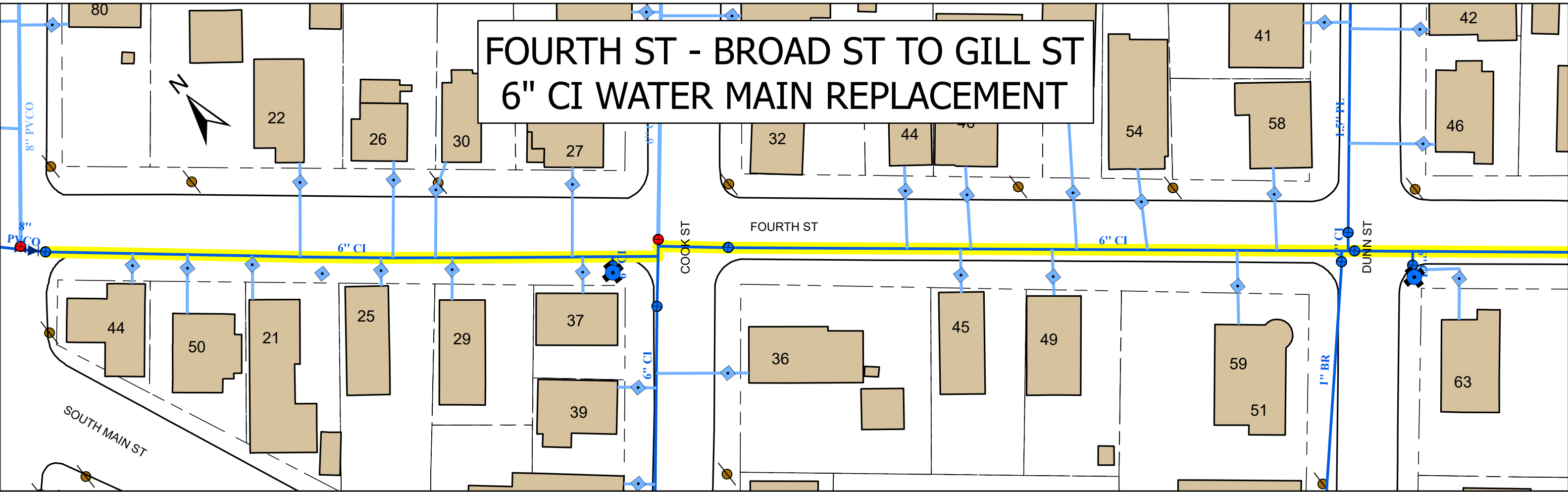

MARIAN DR - BROAD ST TO SHERWOOD DR 6" CICL WATER MAIN REPLACEMENT

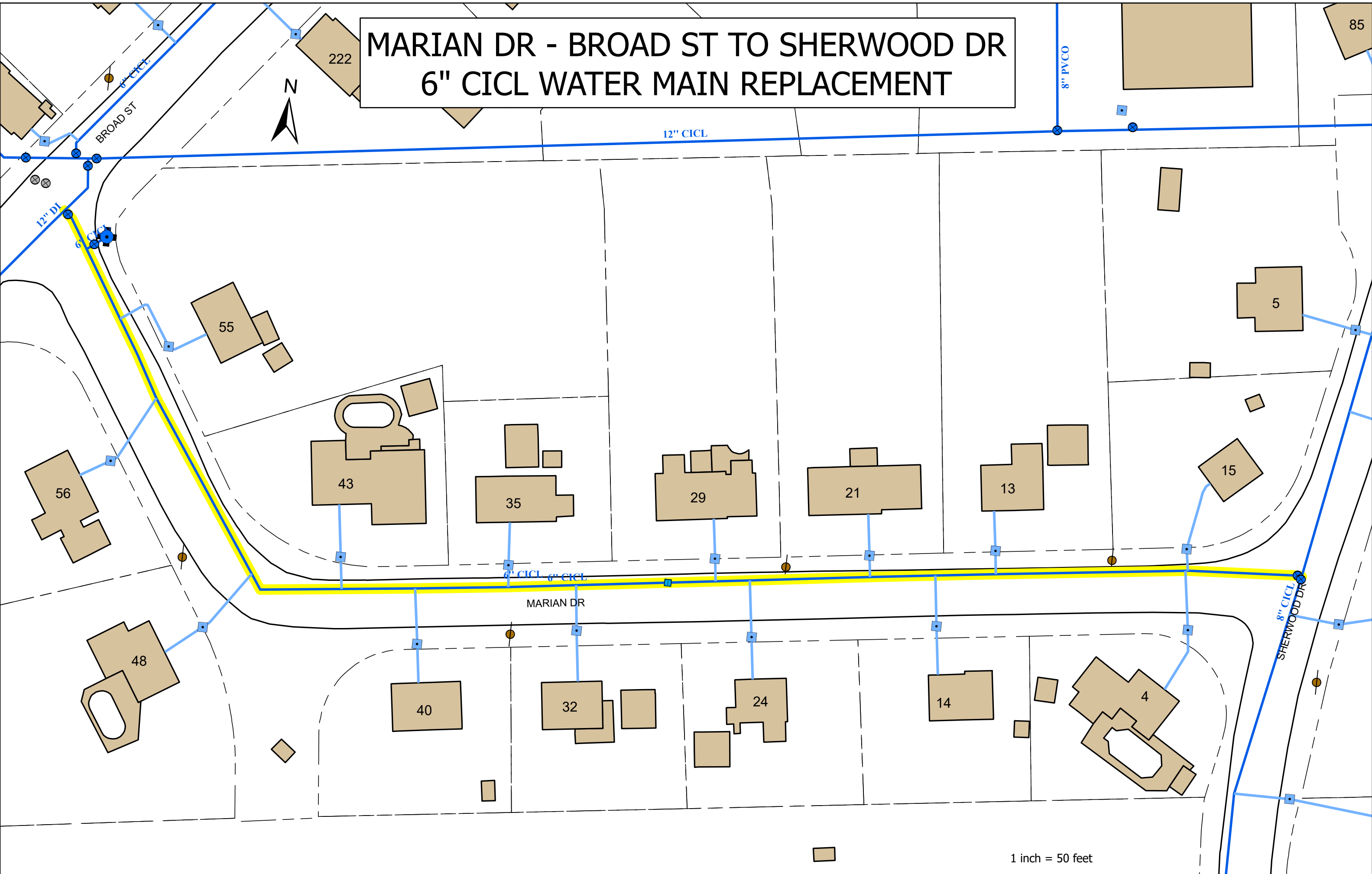

1 inch = 50 feet

APPENDIX B

RECONSTRUCTION PLANS

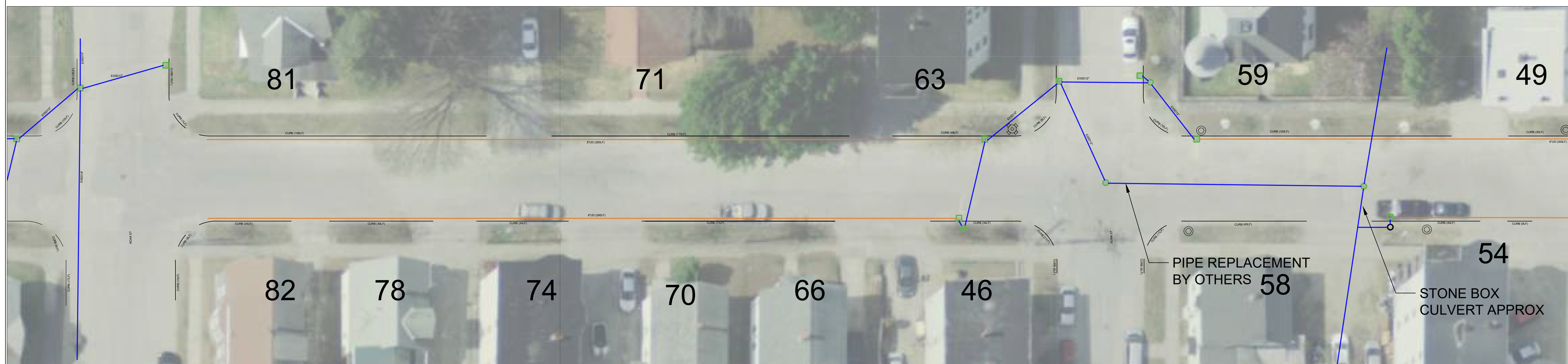

General Notes

1. ROADWAY BUILDUP
 15" - TYPE D GRAVEL
 3" - TYPE A GRAVEL
 2" - 12.5mm HMA BASE
 1.5" - 9.5mm HMA SURFACE
2. PEDESTRIAN WARNING SURFACES
 INSTALLED AT ALL CROSSINGS.

No.	Revision/Issue	Date

Firm Name and Address

Project Name and Address
 2024 RECONSTRUCTION PROJECT
 FOURTH STREET
 AUBURN, ME 04210

Project 2024 RECONSTRUCTION PROJECT	Sheet C01
Date 02/26/2024	
Scale 1" = 20'	

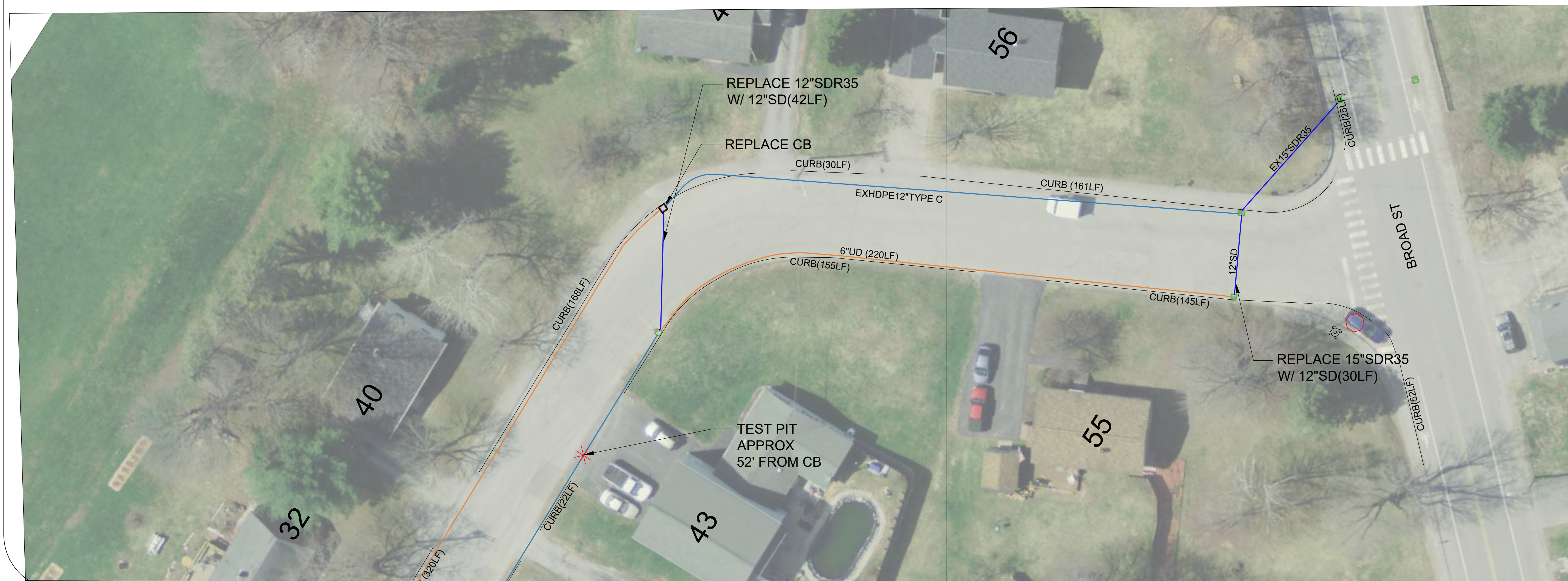
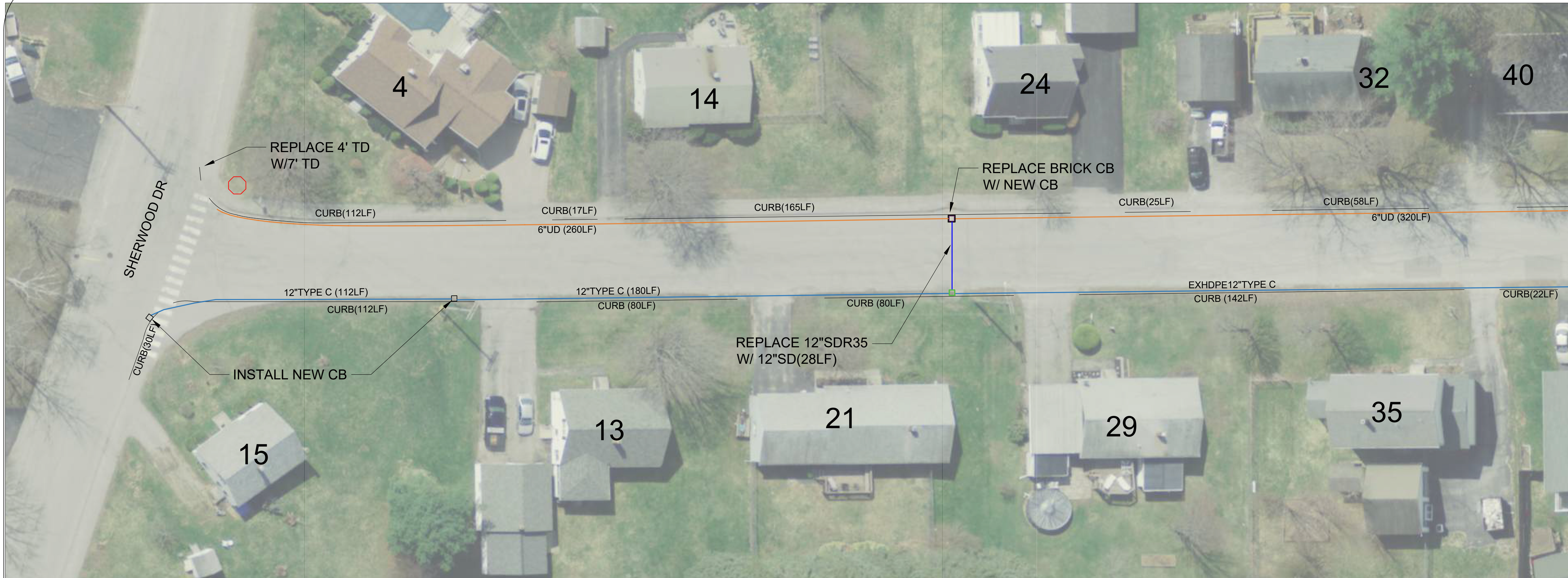

General Notes

1. DRIVEWAY APRON BUILDUP:
 12" - TYPE A GRAVEL
 2" - 12.5mm BASE COURSE
 1" - 9.5mm SURFACE
2. SIDEWALK BUILDUP
 12" - TYPE A GRAVEL
 1" - 9.5mm BASE COURSE
 1" - 9.5mm SURFACE
3. ROADWAY BUILDUP
 15" - TYPE D GRAVEL
 3" - TYPE A GRAVEL
 2" - 12.5mm HMA BASE
 1.5" - 9.5mm HMA SURFACE
4. PEDESTRIAN WARNING SURFACES
 INSTALLED AT ALL CROSSINGS.

No.	Revision/Issue	Date

Firm Name and Address

Project Name and Address
 2024 RECONSTRUCTION PROJECT
 MARIAN DRIVE FOURTH STREET
 AUBURN, ME 04210

Project 2024 RECONSTRUCTION PROJECT	Sheet C02
Date 02/26/2024	
Scale 1" = 20'	

APPENDIX C

**ELECTRICAL SUPPORT
DOCUMENTS**

LIGHT POLE BASE

CUSTOMER:	
JOB NAME:	STOCK ✓
LOCATION:	
TOTAL QTY:	8

DIAMETER (A):	20"
HEIGHT (B):	5'-6"
ABOVE GRADE (C):	TBD
WEIGHT/CY	(1,776 LBS) (0.44 CY)

BOLT SIZE:	3/4" X 18"
BOLT CIRCLE (D):	
BOLT PROJ. (E):	3 1/2"

TYPE OF CONDUIT:	1" & 1 1/2" PVC
CONDUIT DEPTH (F):	2'-6"

GROUND WIRE:	NO
MEDOT:	NO

CONTRACTOR PROVIDED:

- 3/4" x 18" Anchor Bolts
- 3/4" Nuts
- 3/4" Washers
- 1" PVC
- 1 1/2" PVC
- 1 1/2" PVC 90's
- 1 1/2" PVC Couplings

DESIGN NOTES:

1. CONCRETE TO BE MEDOT, CLASS LP. AIR 6.5% ± 1% 5,000 PSI AT 28 DAYS (USE MIX: 10A-LP).
2. REBAR TO BE ASTM A615 GRADE 60, BLACK.
3. REINFORCING: 7 - #6 VERTICALLY WWF 3X8 W3.75/W2.1 HORIZONTALLY.
4. MIN REBAR CLEARANCE, 3" @ ENDS, 2" @ FACE OF CONCRETE.

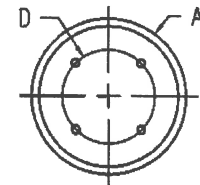

TOP VIEW

CONFIGURATION TABLE:

- QTY: 0 TYPE 1
- QTY: 0 TYPE 2
- QTY: 8 TYPE 3
- QTY: 0 TYPE 4
- QTY: 0 TYPE 5

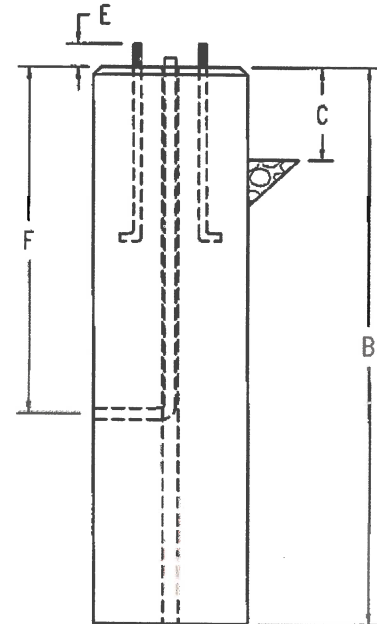

FRONT VIEW

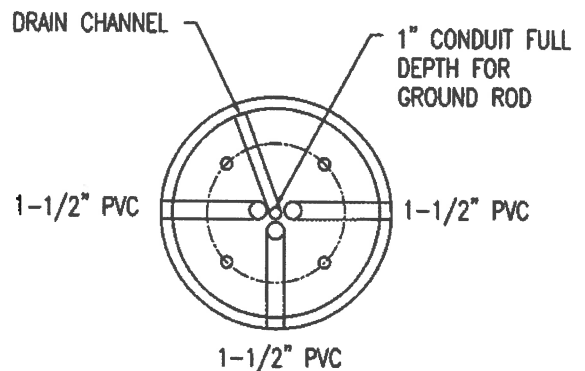

CONDUIT LAYOUT



PRECAST OF MAINE

139 MAIN STREET, P.O. BOX 307
TOPSHAM, ME 04086
207-729-1628, FAX: 207-729-8710

DATE: 8/16/19

DRAWN BY:

DRAWING NUMBER:

CHECKED BY:

1166-LB20X6RND

APPLICATION - NEMA 3R

APX Enclosures, Inc. 3R large single door enclosures are designed to house electronic controls, terminals, and instruments, and to **provide protection from rain, sleet, snow, dripping water and corrosion, while providing ventilation.**

INDUSTRY STANDARD:

U.L. Type 3R, 4X

STANDARD CONSTRUCTION:

(For details see specification sheets.)

A. ENCLOSURE:

1. The complete enclosure is made from .125" thick aluminum alloy type 5052-H32 to provide a strong and rigid construction. Alternative material is 14 gauge type 304 stainless steel. (Specifier must choose the material to be used.)
2. Each enclosure is equipped with two adjustable "C" mounting channels on both side walls, and back wall, providing versatile positioning of shelves, or optional panels or rack mounting angles.
3. The door frame opening is double flanged on all four sides. These flanges increase the strength of door opening and help prevent dust and liquids from dropping into the enclosure when the door is opened.
4. All exterior seams are ground smooth or sealed weathertight with silicone sealant.
5. Pole or wall mounted enclosures have welded stiffener plates to reinforce the top and bottom of rear wall. Welded bottom plates are standard on pole mounted enclosures. A removable bolt-on bottom plate is available as an option.
6. (3R only) Enclosures have provisions for mounting a forced-air fan system that can be thermostatically controlled, and air is exhausted through a slotted vent system in the roof overhang.

B. DOOR:

1. All doors are equipped with a three-point latching mechanism with nylon rollers at the top and bottom.
2. Each door handle is .75" stainless steel round bar and has provisions for a padlock.
3. (3R only) The standard main door lock is Corbin #1548-1 or equal.
4. (3R only) A louvered air vent with filter-retaining brackets and a disposable paper filter element is provided.
5. The main door is sealed with closed-cell neoprene gasket.
6. The continuous door hinge is .075" thick stainless

APPLICATION - NEMA 4X

APX Enclosures, Inc. 4X large single door enclosures are designed to house electronic controls, terminals, and instruments, and to **provide protection from rain, sleet, snow, dripping water and corrosion, as well as hosedown, splashing water, oil or coolant seepage.**

NEMA 3R SHOWN



7. The switch compartment with removable back panel is standard and also made from .125" thick aluminum alloy type 5052-H32. This back can optionally be replaced with a clear lexan window to provide for limited access inspection of operating components or instrumentation.
8. The switch compartment door hinge is 14 gauge stainless steel with a .120 stainless steel hinge pin.

C. FINISH:

1. Natural aluminum enclosures are mill finish per federal specification QQA-250/8.
2. Painted enclosures are treated with an iron phosphate coating and dried by radiant heat. **Black**

~~FOR NEMA TYPE 4X RATING:~~

~~**DELETE** all vents and main door lock (Corbin #1548-1), and Corbin R357SGS switch compartment lock.
ADD Chicago #1703-100-G switch compartment lock.
All through holes are sealed.~~



Highway Tech

Signal Equipment Sales, Inc.
(207) 375-8248

